

L4 Reflect Style

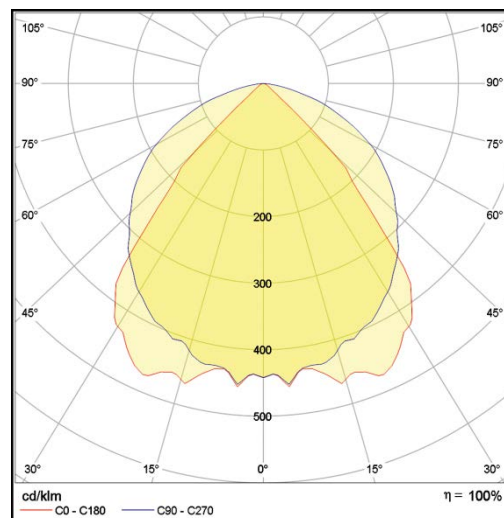

LP-L4-G30-144 850

Art. No 110511541



Luminous flux	4590 lm
Luminaire efficiency	131 lm/W
CRI	> 80
Correlated colour temperature	5000 K
Rated power	35 W
LED	Samsung LM561B
Dimmable	NO
Input current	0.152 A
Working voltage	AC 220-240 V
Ingress protection code	IP67
Mech. impact protection code	IK08
Working temperature	-50 to +45°C

Service life	80 000 hours at 80% luminous flux
Housing	Aluminium
Diffuser	Tempered Glass
Installation	Surface mounting with bracket
Dimensions – LxWxH	373x117x94 mm
Weight	2.6 kg
Mark	CE, RoHS
Origin	EU
Manufacturer	Solar LED Power Ltd.



Dimensional drawing:

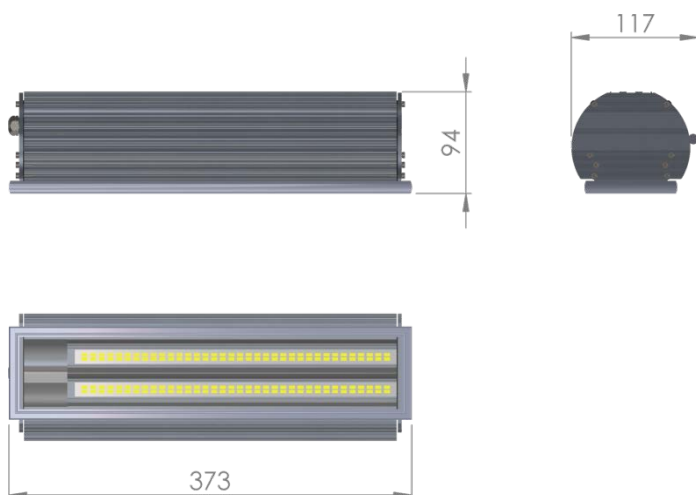

Solar LED Power Ltd. is constantly developing and improving its products. The right is reserved to change specifications without prior notification.